

LEVO *active-easy LAE*

SERVICE-MANUAL



This service manual is designed for use by your LEVO dealer and authorized service technicians.

Please carefully read these instructions before carrying out maintenance work on your wheelchair.

This service manual must be read in connection with the instruction manual.

Alterations in constructional and technical manner or to the electronic require the written authorisation of LEVO AG, otherwise no warranty or product liability will be accepted.

Contents

SERVICE-MANUAL	Fehler! Textmarke nicht definiert.
1. Introduction	3
2. Accident prevention & safety	3
3. Adjustments – general instructions	3
4. Repairs – general instructions	3
5. Tools & torques	4
6. Important notes	4
7. Recommended safety checks	4
8. Adjustments	5
8.1. The backrest and seat upholstery.....	5
8.2. Rear wheel position.....	5
8.3. The castor axle.....	6
8.4. The leg supports.....	6
8.5. Backrest angle.....	7
8.6. The footrest.....	7
8.7. Adjusting the gas spring release.....	8
9. Repairs	8
9.1. Replacing tire/inner tube of rear wheels.....	8
9.2. Repairing the inner tube.....	9
9.3. Replacing the axle adapter.....	9
9.4. Replacing the gas springs.....	10
9.5. Replacing the gas spring release cable.....	10
10. Testing the wheelchair	13
11. Cleaning	13
12. Technical Data	14
13. Crash Testing	15

Introduction

Your **LEVO** *active-easy* is maintenance-free dispensing the user with the need for further maintenance work except for cleaning the wheelchair on a regular basis.

Due to its complex design, the wheelchair should be checked for safety at least once a year by your LEVO dealer or authorized technician.

This service manual has been designed for use by your LEVO dealer or authorized technician. It contains all information required to carry out safety checks and repair works on your **LEVO** *active-easy*. It will ensure that your wheelchair is a reliable, safe and helpful means of transport.

Always read and apply this service manual in connection with the instruction manual.

1. Accident prevention & safety

Accidents can happen. Be aware of possible dangers when carrying out tests or works on your wheelchair. You should take suitable preventive measures to ensure your own safety and that of other persons.

2. Adjustments – general instructions

Depending on the ability of the user's friends and relatives, they may carry out some of the adjustment works themselves. This manual will tell you how to proceed. However, when delivered, your wheelchair should be adjusted to your personal needs by your LEVO dealer or authorized technician.

4. Repairs – general instructions

Service and repair works on the **LEVO** *active-easy* should only be carried out by a LEVO dealer or authorized technician.

- Repairs: For advice in all repairs in Switzerland contact LEVO AG if in Switzerland. For all other countries contact your local LEVO agent. Addresses are given at the front of this instruction and service manual.
- Major repairs: For all major repairs e.g. bent or damaged frame always replace complete components. Never try to repair damaged steelwork or components.
- Replacement parts: Factory replacement components should be used in all repairs, these are available from LEVO AG. To order parts see the parts list drawings at the end of this manual.

Caution: check that the LEVO active-easy is not in the sitting position before carrying out any maintenance or repair work on the wheelchair's stand-up mechanism! Risk of accident! Follow the instructions given in the relevant sections of the service manual!

5. Tools & torques

The following tools are required to carry out maintenance work:

<i>Allen key</i>	Spanner	Cross blade screwdriver	Screw size	<i>Torque in Nm</i>
3mm	10 mm	Flat blade screwdriver	M4	3
4 mm	13 mm	Soft headed hammer	M5	6
5 mm	17 mm	Torque wrench: 0 - 50 Nm	M6	10
6 mm	27 mm		M8	25
8 mm			M10	50
$\frac{3}{16}$ "				

6. Important notes

- Do not reuse Nyloc nuts. Always replace with a new Nyloc nut.
- Always use thread locking compound.
- Always use recommended components and parts available from LEVO AG.
- Do not modify or repair the frame.
- LEVO AG is responsible for any repairs on gas springs, motors and electronic parts.

7. Recommended safety checks

Please note that the following safety checks should be carried out **at least on an annual basis**. Have them carried out only by your LEVO dealer or an authorized technician. If a defect occurs, immediately discontinue using the wheelchair until the defect is remedied.

1. Fold down the backrest and reset. Having put the backrest back in place, check that the clasp latches correctly. Rectify possible defects.
2. Check the frame for possible defects. Replace defective parts if in need of repair.
3. Check seat and backrest covers for possible wear and replace, if necessary.
4. Check the condition of straps, belts and catches and replace, if necessary.
5. Check that nuts, screws, joints and plastic parts are securely tightened as well as for proper condition. Rectify possible defects.
6. Check that push handles and handle covers fit tightly. Rectify possible defects.
7. Check brakes for adequate braking efficiency. Rectify possible defects.
8. Check that front castors and rear wheels run smoothly and are securely fastened. Check tire pressure and the tread of the tire of rear wheels.
9. Check the stand-up mechanism and its proper operation. Rectify possible defects.
10. For the first month, check cable tension on the gas spring-release once a week. You should re-adjust cable tension either weekly or monthly, depending on how often you use the stand-up facility.
11. Check that the gas springs lock and release correctly when you depress the lift activator as part of the stand-up procedure.

8. Adjustments

8.1. The backrest and seat upholstery

The surface flexibility of the backrest upholstery can be adjusted using the velcro fasteners. The backrest can be tightened (for a more upright seated posture) or relaxed (for more back support).

The seat upholstery can be similarly tightened or relaxed by use of velcro fasteners. As a rule it should be as taut as possible. Depending on the height of the cushioning in question, it may be necessary to loosen upholstery surface tension to be able to sink the cushioning down between the two seat supports.

The chest trap is fixed to the backrest upholstery by use of velcro fasteners. It can therefore be adjusted in height.

8.2. Rear wheel position

The axle adapter mounted as standard on your **LEVO** *active-easy* depends on the seat depth.

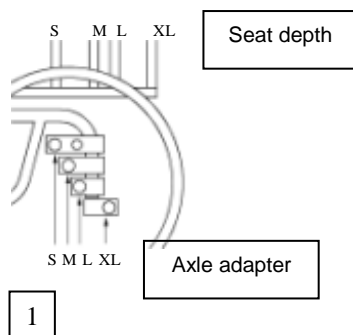

- Seat depth S: axle adapter S mounted.
- Seat depth M: axle adapter M mounted.
- Seat depth L: axle adapter L mounted in forward direction.
- Seat depth XL: axle adapter L mounted in rearward direction. See also illustration 1.
- Seat height 48 cm (22" wheels) and 51 cm (24" wheels): axle adapter mounted at 45 mm from lower end of frame tube. Seat height 54 cm (24" wheels): 20 mm, seat height 57 cm (26" wheels): 30 mm.

To adjust the seat inclination the axle adapter is adjusted in height:

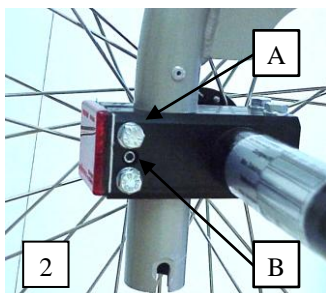

- Unscrew both inside hexagonal screws (A) using a 10 mm spanner and tighten the threaded pin (B) using a 3 mm Allen key (see photo 2). The latter opens up the clamps on the axle adapter.
- Adjust the axle adapter to the desired height, unscrew the threaded pin and tighten the two inner hexagonal screws again.

Caution: When adjusting the height of the axle adapter, be sure to adjust the castor height and angle accordingly (see section 8.3.). In case of large scale adjustments it may even be necessary to replace the leg supports.

Having made the adjustments, it is absolutely vital to ensure that, when standing up, the leg supports still rest on the ground as this is crucial to standing ability (risk of accident!!)

8.3. The castor axle

Having made adjustments to the rear axle, be sure to adjust the castor height and angle accordingly. When carrying out these adjustments, it is important to bear the following points in mind:

- The castor axle should stand at a right angle to the ground.
- The castor should always remain in contact with the ground.
- In the uppermost standing position, the leg supports must be resting on the ground.

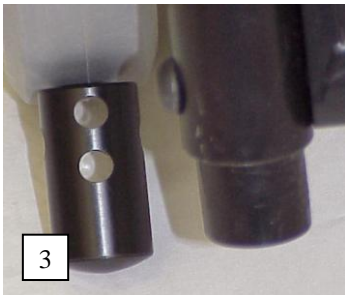

- Bring the **LEVO active-easy** into the standing position.
- Unscrew and remove the cylindrical screws using a 4 mm Allen key, then set the plastic leg plug either higher or lower so that the leg supports are standing on the ground. You may have to turn the leg plug by 90°. (see photo 3).

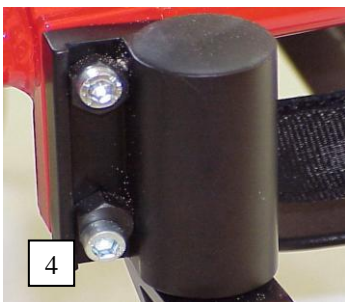

- Unscrew the two cylindrical screws using a 5 mm Allen key and turn the eccentric disc until the axle is sitting vertically (see photo 4). You may have to turn only one of the two eccentric discs. Screw the cylindrical screws tight.

8.4. The leg supports

The leg supports should be replaced when the seat height of the wheelchair has been so greatly adjusted that they no longer reach the ground or reach the ground too soon in the uppermost standing position.

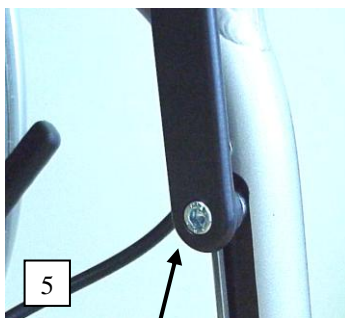

- Remove the rear wheels (see Instruction Manual, section B.1.)
- Remove the footrest (see section 8.6.).
- Loosen the cylindrical screws on both inner sides of the leg supports and remove them together with the spacer bushing (see photo 5). Then pull the leg supports out of the frame.
- Replace the leg supports and reassemble in reverse order.

8.5. Backrest angle

The backrest sits at an angle of 90° to the seat as standard but can be adjusted in either direction by 5° . This adjusting mechanism is not stepless.

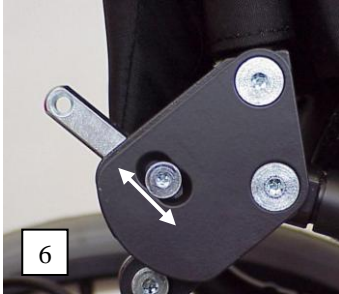

- Remove the rear wheels, then remove the skirt guards (see Instruction Manual, section 3.1.).
- Unscrew the countersunk screw on the outer joint using a 4 mm Allen key, remove the screw and the bushing (see photo 6) before adjusting to the desired position and tightening up the countersunk screw.

Attention: Having adjusted the backrest angle, check that the clasp of the folding mechanism latches correctly!

8.6. The footrest

The height of the footrest is not only important for a good sitting position but even more so for the standing position. On delivery you will find the footrest at the second lowest position, if not ordered specifically.

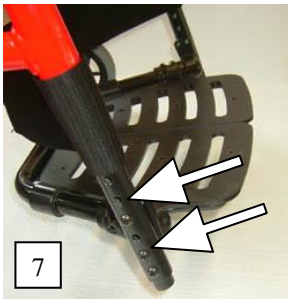

- There is a choice of 5 different heights for mounting the footrest.
- Unscrew the four oval head screws on both outer edges of the footrest using a 4 mm Allen key and set the footrest either higher up or lower down (see photo 7).

There are three possible footrest angle variations:

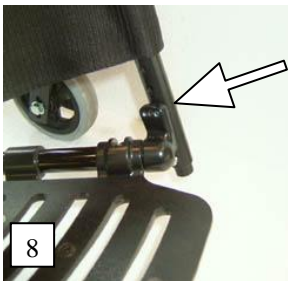

- 4° to the horizontal
- 14° to the horizontal (standard)
- 24° to the horizontal
- Unscrew the four oval head screws on both outer edges of the footrest using a 4 mm Allen key and remove the upper ones. Set the footrest at the desired angle and retighten the screws (see photo 8).
-

The footrest angle is set as standard at 14° to the horizontal. With the footrest in the lowest possible setting, an angle of 4° is the only practicable variation as the footrest otherwise touches the ground before the leg supports (hence no standing stability!).

With the second lowest setting the only potential variations are 4° and 14° , for the same reasons. For all higher footrest settings there is a choice of all three angle variations.

8.7. Adjusting the gas spring release

It is important to check that the gas springs respond to the gas spring release lever and lock and release correctly as part of the standing up.

Caution: When checking the gas spring release, the gas springs should be extended, i.e. the wheelchair should be in a standing position! Risk of accident!

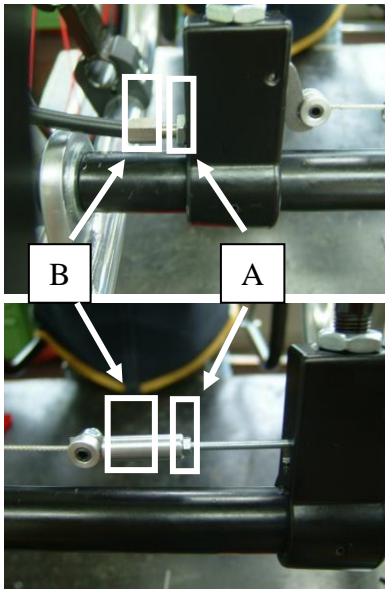

- If the gas springs are sluggish on release, the cable tension is not tight enough. Loosen the counter nut (A) using a 10 mm Allen key and turn the adjustment screw (B) one turn to the left using a 8 mm spanner (anti-clockwise).
- If the gas springs are not locking properly, the cable tension is too tight. Loosen the counter nut (A) and turn the adjustment screw (B) one turn to the right (clockwise).
- Repeat until the gas springs lock correctly.
- See also section 9.5., Important check.

9. Repairs

9.1. Replacing tire/inner tube of rear wheels



- Remove the wheel and open the valve before pressing down on it to let out the air (see photo 10).
- Using a bicycle tire wedge, ease both sides of the tire over the wheel rim and pull the inner tube out of the tire (see photo 11).
- Replace the inner tube by forcing one side of the tire back over the wheel rim, pump up the tire a little, ease the valve through into the hole and lay the inner tube along inside of the tire. Once the whole tube is snug inside the tire, force the other side of the tire back over the wheel rim (starting on the side opposite the valve).
- Check lest the inner tube be caught between tire and rim before pumping it up in line with the manufacturer's recommended tire pressure (see Technical Data, section 12).

9.2. Repairing the inner tube

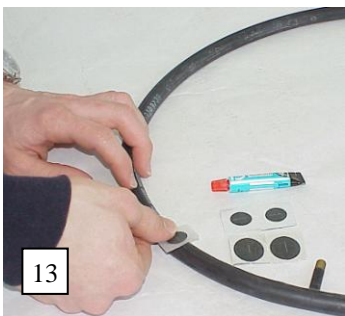
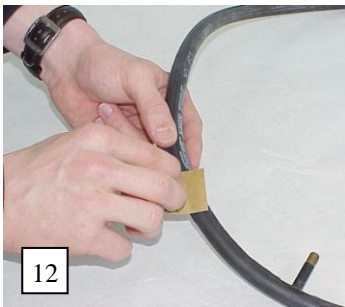

- Remove inner tube and tire following the steps described under 9.1.
- Repair the hole using a bicycle puncture repair kit and follow the manufacturer's instructions (clean the area around the hole and roughen the tube surface (see photo 12) before applying the vulcanized solution. Allow to dry, then firmly attach the rubber patch (see photo 13). Again, first allow to dry, then pump up the tube to check that the patch is airtight).
- Replace the inner tube. Once the whole tube is snug inside the tire, force the tire back over the wheel rim (starting on the side opposite the valve).
- Check lest the inner tube be caught between tire and rim before pumping it up in line with the manufacturer's recommended tire pressure (see Technical Data, section 12).

9.3. Replacing the axle adapter

There are a variety of axle adapters available by use of which the wheel axle can be set further forward or further back to increase or decrease respectively the tendency of the wheelchair to tip over, see section 8.2..

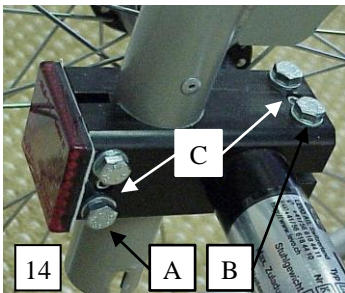

- Loosen the inside (A) and top (B, on the right hand side, but bottom on the left) hexagonal screws using a 10 mm spanner, then tighten both threaded pins (C) using a 3 mm Allen key (see photo 14).
- Slide the axle adapter off the tubular frame and the axle itself and replace it.
- Set the new axle adapter to the desired height, loosen the two threaded pins and screw the two hexagonal screws tight.

9.4. Replacing the gas springs

Should you have to replace the gas springs, for example, to boost or reduce their resistance, ensure first that they are not extended (too long, i.e. the wheelchair should be in half seated or **almost** upright position, but not in the fully upright standing position). It is important that the gas springs are the same length.



- Unscrew the gas springs on both sides simultaneously turning them to the right (clockwise) to remove them from the rear gas spring holders (see photo 15).

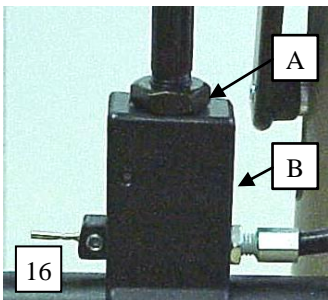

- Unscrew the counter nut (A) on the front of the spring using a 17 mm spanner and unscrew the spring to remove it from the front gas spring holder (B) (see photo 16).
- The new gas springs should have the same length, but not be fully extended. Mount in reverse order.

9.5. Replacing the gas spring release cable

Caution: When replacing one or both gas spring release cables, the gas springs should be extended, i.e. the wheelchair should be in a standing position! Risk of accident!

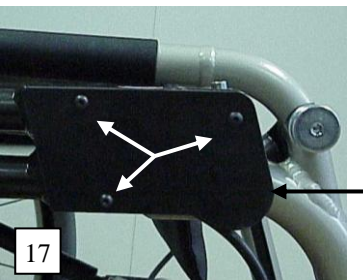

- Remove the small cover by unscrewing the three countersunk screws using a 2.5 mm Allen key.

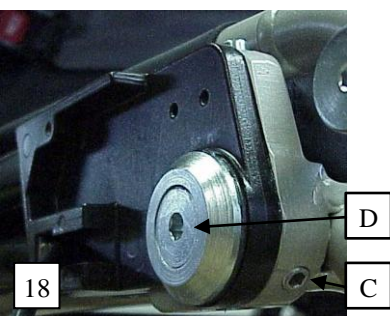

- Loosen and remove the threaded pin (C) and the countersunk screw (D) using a 4 mm and 6 mm Allen key (see photo 18). Take off the complete armrest.

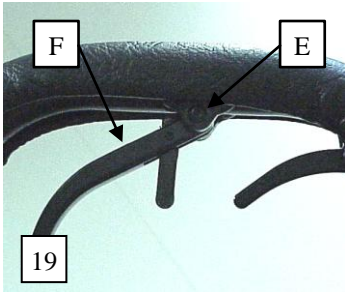

- Loosen and remove the screw (E) on the gas spring release lever (F) using a 3 mm Allen key (see photo 19). Take the gas spring release lever off the armrest and pull the cable out.

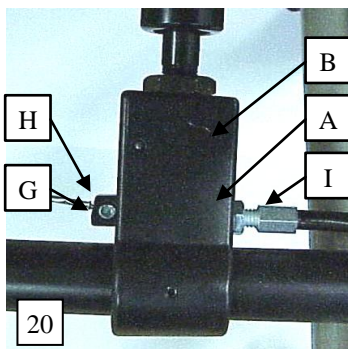

- Loosen the threaded pin (G) on the trigger lever (H) in the front gas spring holder (B) using a 3 mm Allen key and pull the cable out. Remove the cable coating as well as the adjustment screw (I) and the counter nut (A) using a 8 mm and 10 mm spanner (see photo 20).

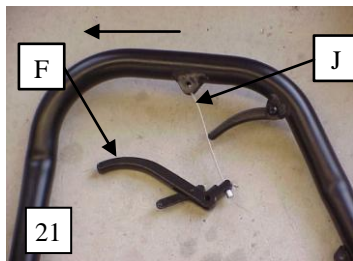

- Mounting the new cable:
Insert the new gas spring release cable (J) through the release lever (F) and into the armrest towards the rear and down in direction of the arrow (see photo 21).
- Insert the release lever (F) into the armrest: **Attention:** the other cable, the one of the armrest release mechanism, must run lateral of the gas spring release lever! It must not run above the gas spring release lever!
- See the assembly schema below, for the new release mechanism.

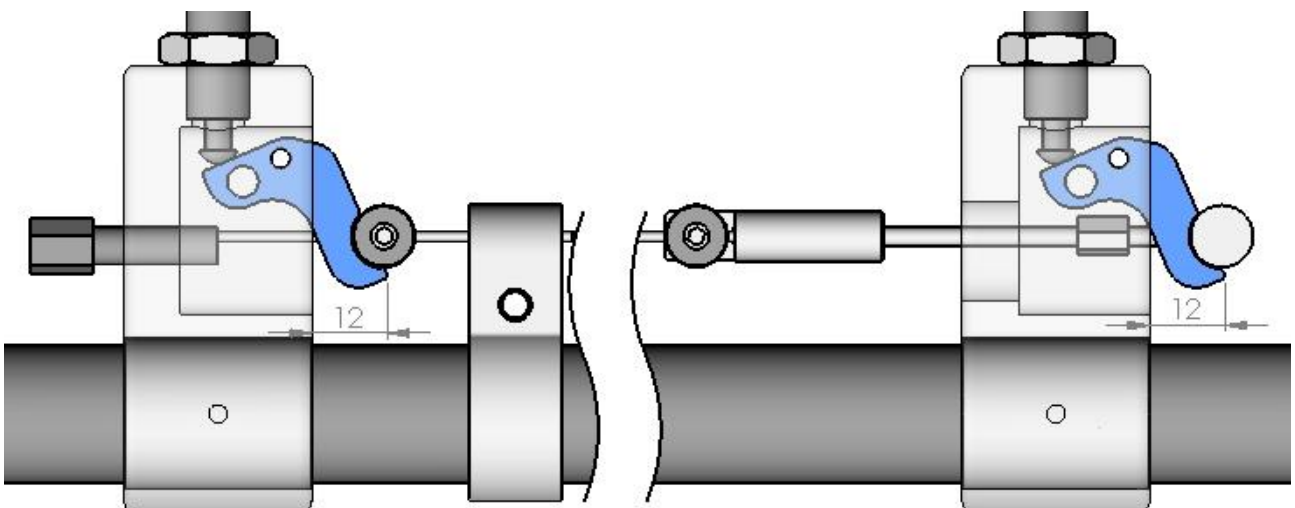

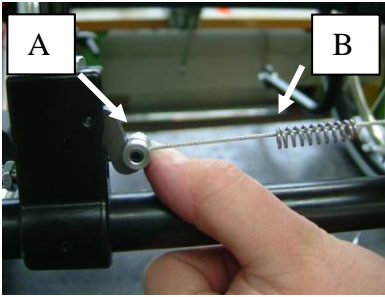

- go with the cable through the cable clamp (A)
- Put the spring over the cable (B)



- use a brake cable plier (02.001.0230) to stretch the cable
- tighten the nut

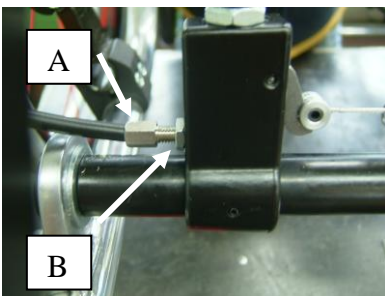

- Check if both levers are releasing the gas springs if not, adjust the cable system with the adjustment screws (A)
- Lock the secure nut.



- Cut the cable to the right size.
- Lock the secure nut.



- Adjust the cable system with the adjustment bolt

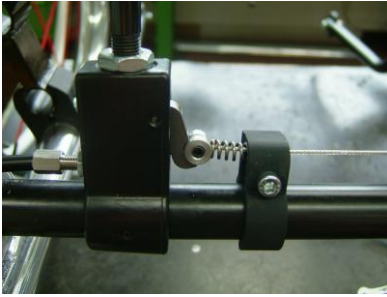

- Mount the “gas spring release assistance system”
- As harder you push the “gas spring release assistance system” against the gas spring holder, as easier can you release the gas springs.
- Attention: Already a few mm can change the performance of the release function

Important check: when moving the visible part of the cable/cable coating the gas spring release mechanism should not be activated!

- If the gas springs don’t release sufficiently, the trigger lever (H) is not being pulled far enough into the gas spring holder (B) when the gas spring release lever (F) is pressed. The cable tension is too sluggish. It must be adjusted, see section 8.7..
- If the gas springs don’t lock sufficiently, the trigger lever (H) sits too deep in the gas spring holder (B). The cable tension is too tight. It must be adjusted, see section 8.7..

10. Testing the wheelchair

After having carried repairs on a wheelchair, you should always check all functions for correct operation before returning the wheelchair to your customer. The wheelchair should only be returned after all defects have been rectified.

11. Cleaning

Before you return the wheelchair to your customer, make sure that the wheelchair is clean and dry:

- Remove dirt with a damp cloth and wipe dry.
- In the case of stubborn dirt use a mild detergent and warm water for cleaning.
- Never apply furniture polish, spirit or solvents to clean the wheelchair.

12. Technical Data

Measurements

Model	M				L				XL			
Seat width	38	40	42	45	38	40	42	45	38	40	42	45
Total width	58	60	62	65	58	60	62	65	58	60	62	65
Total length	85				93				100			
Total height (with backrest)	77				80				79			
Back upholst. height	31				31				31			
Seat upholst. height front	48				51 / 54				54 / 57			
Seat upholst. height rear	45				47 / 50				49 / 52			
Seat upholst. depth	38				43				52			
Footrest - seat	35 - 42				38 - 45 / 41 - 48				41 - 48 / 44 - 52			
Weight without wheels	12.5				13.5				14.5			
Total weight	18				19				20			

All measurements in cm and kg. Variations due to model-specific adjustments possible.

Tires:

Rear wheels: High pressure tires, 22"/24"/26"

Tire pressure (rear): 7.5 bar

Front castor: airless tires, 5"/6"

Gas springs: 2 blocking gas springs

LAE/M: 500 N

LAE/L: 600 N

LAE/XL: 700 N

Operating temperature range: +5° - +40°

Storage temperature range: -40° - +60°

Clearance: max. 6 cm

Max. height of obstacle: max. 2 cm

Max. permissible gradient/

Cross-fall: max. 3°

Max. weight

incl. body & load: max. 120 kg

13. Crash Testing

LEVO

LEVO active-easy LAE

passed the crash test after the ISO 7176/19
and ANSI/RESNA WC/Vol. 1-Section 19

The **LEVO active-easy LAE** has been positively crash tested for car transportation after the norms mentioned above. Please read the information/instructions below:

Certified test centre: Millbrook Proving Ground Ltd, Bedford MK45 2JQ, England
 Millbrook Report No: MBK 07/0231 (and MBK 07/0232)
 Millbrook Test No: S9804 (and S9806)
 Restraints Wheelchair: Q'Straint 5001-T2 (<http://www.qstraint.com/english/products/products.aspx>)
 Restraints Occupant: Q'Straint Vehicle Anch 3-Pt
 Requirements ISO 7176/19: PASS
 And ANSI/RESNA Section 19: PASS

Preparations of the **LEVO active-easy LAE** before using it for car transportation:

1. The chair has to be equipped and reinforced with the "tight down transportation kit # 32.070.0300" that can be ordered at LEVO AG through your LEVO distributor (see instructions below – in black colour).
2. The chair has to be tight down by using the Q'Straint 5001-T2 or any restraint system that has been tested and passed the ISO 10542/2 standards (see instructions below – in grey colour).
3. The occupant has to be safely secured by using the Q'Straint Vehicle Anch 3-Pt or any restraint system that has been tested and passed the ISO 10542/2 standards (see instructions below – in grey colour).

